

Dispensing Solutions

ADHESIVE & SEALANT APPLICATIONS



1- AND 2-COMPONENT DISPENSERS



INDUSTRY





OUR BRANDS AT MEDMIX INDUSTRY

medmix Industry delivers one of the world's leading hand-held mixing and dispensing systems for adhesives and sealants. We have strong partnerships with industrial manufacturing, production, coating, and construction leaders that have lasted for close to 100 years.

Through our brands COX™ and MK™, we bring together the best expertise in one and two-component adhesive applications. MIXPAC™ is the leading system provider in the area of mixing, dosing and applying, COX provides a wide range of professional, practical dispensers, and MK is the specialist in customized high-quality dispensing solutions.

The MK product range, originally founded by Krøger A/S in 1922 and acquired by us in 2013 – includes manual, battery and pneumatic driven dispensers for any application.

Originally established in 1958 by Patrick Clement Cox, COX has become the global market leader in the design and production of manual, pneumatic and battery hand held sealant and adhesive applicators. The product range includes cartridge, sachet, bulk and one and two-component dispensers.

This tradition, quality, reliability and performance of the MK and COX dispensers continues into the future at the medmix Industry segment, and the renowned MK and COX dispensers are available through the Sulzer Mixpac affiliates of the medmix group. All of our MK, COX and MIXPAC brand dispensers may be recognized by their well-known unique and pleasing visual appearances.

MANUAL 1-COMPONENT DISPENSER

EASIFLOW™ HD LITE



FEATURES

- Retractable Seal Puncturing Device
- Pressure Relief Device (PRD)
- Built-in Ladder Hook
- Steel Catch Plate

SPECIFICATIONS

- Cartridge Capacity: 310 mL / 10.5 oz
- Mechanical Advantage Ratio: 7:1
- Weight: 0.32 kg / 0.71 lbs
- Frame Length: 234 mm / 9.21 in
- Maximum Force: 1.2 kN / 269 lbf
- Handle Material: Glass Fiber Reinforced Nylon
- Frame Material: Glass Fiber Reinforced Nylon
- Viscosity: Low

Item number: 159197



EASIFLOW™ HD



FEATURES

- Retractable Seal Puncturing Device
- Pressure Relief Device (PRD)
- Built-in Ladder Hook
- Steel Catch Plate

SPECIFICATIONS

- Cartridge Capacity: 310 mL / 10.5 oz
- Mechanical Advantage Ratio: 7:1
- Weight: 0.51 kg / 1.1 lbs
- Frame Length: 231 mm / 9.1 in
- Maximum Force: 1.2 kN / 269 lbf
- Handle Material: Epoxy Coated Steel
- Frame Material: Epoxy Coated Steel
- Viscosity: Low

Item number: 159200



POWERFLOW™ CARTRIDGE



FEATURES

- Seal Puncture Device
- Rotating Frame
- Built-in Ladder Hook
- Switchable Pressure Relief Device (PRD)

SPECIFICATIONS

- Cartridge Capacity: 310 mL / 10.5 oz
- Mechanical Advantage Ratio: 12:1
- Weight: 0.75 kg / 1.65 lbs
- Frame Length: 233 mm / 9.2 in
- Maximum Force: 2.5 kN / 562 lbf
- Handle Material: Epoxy Coated Aluminum
- Frame Material: Epoxy Coated Steel
- Viscosity: Low/Medium

Item number: 159207



H1X



FEATURES

- Seal Puncture Device
- Anti-Drip
- Trigger Integrated Brake Release
- Built-in Ladder Hook
- Life Prolonging Adjustment Screw

SPECIFICATIONS

- Cartridge Capacity: 310 mL / 10.5 oz
- Mechanical Advantage Ratio: 12:1
- Weight: 0.55 kg / 1.21 lbs
- Frame Length: 225 mm / 8.9 in
- Maximum Force: 2.5 kN / 562 lbf
- Handle Material: Reinforced Nylon
- Frame Material: Reinforced Nylon
- Viscosity: Low/Medium

Item number: 183818



MANUAL 1-COMPONENT DISPENSER

H14RS



FEATURES

- Seal Puncture Device
- Rotating Frame
- Anti-Drip
- Trigger Integrated Brake Release
- Life Prolonging Adjustment Screw

SPECIFICATIONS

- Cartridge Capacity: 310 mL / 10.5 oz
- Mechanical Advantage Ratio: 12:1
- Weight: 0.77 kg / 1.7 lbs
- Frame Length: 243 mm / 9.5 in
- Maximum Force: 2.5 kN / 562 lbf
- Handle Material: Reinforced Nylon
- Frame Material: Steel
- Viscosity: Low/Medium

Item number: 180788



POWERFLOW™ HP CARTRIDGE



FEATURES

- Seal Puncture Device
- Rotating Frame
- Built-in Ladder Hook
- Switchable Pressure Relief Device (PRD)

SPECIFICATIONS

- Cartridge Capacity: 310 mL / 10.5 oz
- Mechanical Advantage Ratio: 18:1
- Weight: 0.8 kg / 1.7 lbs
- Frame Length: 233 mm / 9.2 in
- Maximum Force: 3.5 kN / 787 lbf
- Handle Material: Epoxy Coated Aluminum
- Frame Material: Epoxy Coated Steel
- Viscosity: Medium/High

Item number: 159211



H40PS



FEATURES

- Seal Puncture Device
- Rotating Frame
- Anti-Drip
- Trigger Integrated Brake Release
- Soft Grip Handle

SPECIFICATIONS

- Cartridge Capacity: 310 mL / 10.5 oz
- Mechanical Advantage Ratio: 18:1
- Weight: 0.60 kg / 1.3 lbs
- Frame Length: 230 mm / 9.1 in
- Maximum Force: 3.5 kN / 787 lbf
- Handle Material: Reinforced Nylon
- Frame Material: Reinforced Nylon
- Viscosity: Medium/High

Item number: 180891



H40+



FEATURES

- Seal Puncture Device
- 360 Frame Rotation
- Trigger-integrated Brake Release with Anti-Drip Mechanism
- Single Hand Grip Dispensing Operation
- Ergonomic Handle
- U-Shaped Opening Cartridge Holder

SPECIFICATIONS

- Cartridge Capacity: 310 mL / 10.5 oz
- Mechanical Advantage Ratio: 18:1
- Weight: 0.95 kg / 2.1 lbs
- Frame Length: 242 mm / 9.5 in
- Maximum Force: 3.5 kN / 787 lbf
- Handle Material: Aluminum
- Frame Material: Steel
- Viscosity: Medium/High

Item number: 183818



MANUAL 1-COMPONENT DISPENSER

ULTRAFLOW™ CARTRIDGE



FEATURES

- Rotating Frame
- Support Straps
- Built-in Ladder Hook
- Thumb Activated Instant Pressure Release

SPECIFICATIONS

- Cartridge Capacity: 310 mL / 10.5 oz
- Mechanical Advantage Ratio: 25:1
- Weight: 0.90 kg / 1.34 lbs
- Frame Length: 243 mm / 9.57 in
- Maximum Force: 4.5 kN / 1011 lbf
- Handle Material: Epoxy Coated Aluminum
- Frame Material: Anodized Steel
- Viscosity: High

Item number: 159208



H245



FEATURES

- U-Opening with Cartridge Snap Fit
- Anti-Drip
- Trigger Integrated Brake Release
- Life Prolonging Adjustment Screw

SPECIFICATIONS

- Cartridge Capacity: 310 mL / 10.5 oz
- Mechanical Advantage Ratio: 26:1
- Weight: 0.8 kg / 1.7 lbs
- Frame Length: 250 mm / 9.8 in
- Maximum Force: 4.5 kN / 1011 lbf
- Handle Material: Reinforced Nylon
- Frame Material: Reinforced Nylon
- Viscosity: High

Item number: 151727



POWERFLOW™ QUART



FEATURES

- Seal Puncture Device
- Rotating Frame
- Switchable Pressure Relief Device (PRD)
- Built-in Ladder Hook

SPECIFICATIONS

- Cartridge Capacity: 946 mL / 32 oz
- Mechanical Advantage Ratio: 12:1
- Weight: 0.79 kg / 1.7 lbs
- Frame Length: 274 mm / 10.78 in
- Maximum Force: 2.5 kN / 562 lbf
- Handle Material: Epoxy Coated Aluminum
- Frame Material: Epoxy Coated Steel
- Viscosity: Low/Medium

Item number: 159203



POWERFLOW™ HP QUART



FEATURES

- Seal Puncture Device
- Rotating Frame
- Switchable Pressure Relief Device (PRD)
- Built-in Ladder Hook

SPECIFICATIONS

- Cartridge Capacity: 946 mL / 32 oz
- Mechanical Advantage Ratio: 18:1
- Weight: 0.79 kg / 1.7 lbs
- Frame Length: 274 mm / 10.78 in
- Maximum Force: 3.5 kN / 787 lbf
- Handle Material: Epoxy Coated Aluminum
- Frame Material: Epoxy Coated Steel
- Viscosity: Medium/High

Item number: 159206



MANUAL 1-COMPONENT DISPENSER

MIDIFLOW™ COMBI



FEATURES

- Pre-Configured for Sachet Application
- Plungers Included for Cartridge
- Includes Six White Cone Nozzles

SPECIFICATIONS

- Cartridge Capacity: 310 mL / 10.5 oz
- Sachet Capacity: 310 mL / 10.5 oz, 400 mL / 13.5 oz, 600 mL / 20 oz
- Mechanical Advantage Ratio: 10:1
- Weight 0.67 kg / 1.5 lbs
- Barrel Length: 377 mm / 14.84 in
- Maximum Force: 1.5 kN / 337 lbf
- Handle Material: Glass Fiber Reinforced Nylon
- Barrel Material: ABS Polymer
- Viscosity: Low/Medium

Item number: 159199



POWERFLOW™ COMBI



FEATURES

- Pre-Configured for Sachet Application
- Plungers Included for Cartridge and Bulk Applications
- Switchable Pressure Relief Device (PRD)
- Includes Six Yellow Cone Nozzles, Ladder Hook

SPECIFICATIONS

- Cartridge Capacity: 310 mL / 10.5 oz
- Sachet Capacity: 310ml / 10.5 oz, 400 mL / 13.5 oz, 600ml / 20 oz
- Mechanical Advantage Ratio: 12:1
- Weight: 0.9-1.1 kg / 2.0-2.3 lbs
- Barrel Length: 231 mm / 9.1 in
- Maximum Force: 2.5 kN / 562 lbf
- Handle Material: Epoxy Coated Aluminum
- Barrel Material: Anodized Aluminum
- Viscosity: Low/Medium

Item number: 159219 (10.5 oz)
159231 (20 oz)



POWERFLOW™ HP COMBI



FEATURES

- Pre-Configured for Sachet Application
- Plungers Included for Cartridge and Bulk Applications
- Switchable Pressure Relief Device (PRD)
- Includes Six Yellow Cone Nozzles, Ladder Hook

SPECIFICATIONS

- Cartridge Capacity: 310 mL / 10.5 oz
- Sachet Capacity: 310ml / 10.5 oz, 400 mL / 13.5 oz, 600ml / 20 oz
- Mechanical Advantage Ratio: 18:1
- Weight: 0.9-1.1 kg / 2.0-2.3 lbs
- Barrel Length: 231 mm / 9.1 in
- Maximum Force: 3.5 kN / 787 lbf
- Handle Material: Epoxy Coated Aluminum
- Barrel Material: Anodized Aluminum
- Viscosity: Medium/High

Item number: 159277 (10.5 oz)
159244 (20 oz)



H2



FEATURES

- Suitable for Both Sachet and Bulk
- Anti-Drip
- Trigger Integrated Brake Release
- Bayonet Mouth Piece
- Includes 1 Yellow Nozzle

SPECIFICATIONS

- Sachet/Bulk Capacity: 310 mL / 10.5 oz, 400 mL / 13.5 oz, 600 mL / 20 oz
- Mechanical Advantage Ratio: 18:1
- Weight: 1.65 kg / 3.6 lbs
- Barrel Length: 398 mm / 15.6 in
- Maximum Force: 3.5 kN / 787 lbf
- Handle Material: Aluminum
- Frame Material: Polished Steel
- Viscosity: Medium/High

Item number: 151726



MANUAL 1-COMPONENT DISPENSER

ULTRAFLOW™ COMBI



FEATURES

- Pre-Configured for Sachet Application
- Plungers Included for Cartridge & Bulk Applications
- Includes Six Yellow Cone Nozzles, Ladder Hook

SPECIFICATIONS

- Cartridge Capacity: 310 mL / 10.5 oz
- Sachet Capacity: 300 mL / 10.5 oz, 400 mL / 13.5 oz, 600 mL / 20.3 oz
- Mechanical Advantage Ratio: 25:1
- Weight: 1.0-1.1 kg / 2.2-2.5 lbs
- Barrel Length: 342 mm-482 mm / 13.5 in-19.0 in
- Maximum Force: 4.5 kN / 1011 lbf
- Handle Material: Epoxy Coated Aluminum
- Barrel Material: Anodized Aluminum
- Viscosity: High

Item number: 159234



ULTRAFLOW™ BULK



FEATURES

- Leather Plunger Assembly
- Switchable Pressure Relief Device (PRD)
- Interchangeable Pull Handle
- Includes Six Yellow Cone Nozzles

SPECIFICATIONS

- Bulk Material Capacity: 600 mL / 20.3 oz, 800 mL / 28oz., 1000 mL / 33.8 oz
- Mechanical Advantage Ratio: 12:1
- Weight: 1.1-1.3 kg / 2.4-2.9 lbs
- Barrel Length: 355 mm-510 mm / 14 in-21 in
- Maximum Force: 2.5 kN / 562 lbf
- Handle Material: Epoxy Coated Aluminum
- Barrel Material: Anodized Aluminum
- Viscosity: Low/Medium

Item number: 159255 (600 mL)

159257 (800 mL)

159248 (1000 mL)



ULTRAPPOINT™



FEATURES

- Trowel/Pour Material into Tube for Dispensing
- Switchable Pressure Relief Device (PRD)
- Interchangeable Pull Handle
- Point, Grout Nozzles and Turbine Mixer Included

SPECIFICATIONS

- Bulk Capacity: 800 mL / 28 oz
- Mechanical Advantage Ratio: 12:1
- Weight: 1.42 kg / 3.13 lbs
- Frame Length: 233 mm / 9.3 in
- Maximum Force: 2.5 kN / 562 lbf
- Handle Material: Epoxy Coated Aluminum
- Barrel Material: Black PVC
- Frame Material: Epoxy Coated Steel
- Viscosity: Low/Medium

Item number: 159215



PNEUMATIC 1-COMPONENT DISPENSER

AIRFLOW™ 2 CARTRIDGE



FEATURES

- Air Action on Cartridge Plunger
- Adjustable Air Regulator
- Quick Exhaust Valve
- Silencer

SPECIFICATIONS

- Cartridge Capacity: 310 mL / 10.5 oz
- Weight: 0.73 kg / 1.6 lbs
- Barrel Length: 228 mm / 8.9 in
- Maximum Force: 1.2 kN / 269 lbf
- Maximum Pneumatic Pressure: 6.8 bar / 100 psi
- Handle Material: Glass Filled Nylon
- Barrel Material: Anodized Aluminum
- Viscosity: Low

Item number: 159323



AIRFLOW™ 3 CARTRIDGE



FEATURES

- Air Action on Cartridge Plunger
- Adjustable Air Regulator
- Quick Exhaust Valve
- Silencer

SPECIFICATIONS

- Cartridge Capacity: 310 mL / 10.5 oz
- Weight: 0.60 kg / 1.3 lbs
- Barrel Length: 235 mm / 9.2 in
- Maximum Force: 1.2 kN / 269 lbf
- Maximum Pneumatic Pressure: 6.8 bar / 75 psi
- Handle Material: Glass Filled Nylon
- Barrel Material: Anodized Aluminum
- Viscosity: Low

Item number: 159336



T1



FEATURES

- Air Action on Cartridge Plunger
- Integrated Pressure Adjustment
- Self Adjusting Back Seal
- Forward Air Release
- Cartridge Snap Fit

SPECIFICATIONS

- Cartridge Capacity: 310 mL / 10.5 oz
- Weight: 0.41 kg / 0.90 lbs
- Frame Length: 249 mm / 9.8 in
- Maximum Force: 1.3 kN / 292 lbf
- Maximum Pneumatic Pressure: 8 bar / 116 psi
- Handle Material: Reinforced Nylon
- Frame Material: Reinforced Nylon
- Viscosity: Low/Medium

Item number: 151774



T16X



FEATURES

- Air Action on Cartridge Plunger
- Integrated Pressure Adjustment
- Beveled Back Seal
- Forward Air Release
- Cartridge Snap Fit

SPECIFICATIONS

- Cartridge Capacity: 310 mL / 10.5 oz
- Weight: 0.88 kg / 1.94 lbs
- Frame Length: 228 mm / 9.0 in
- Maximum Force: 1.3 kN / 292 lbf
- Maximum Pneumatic Pressure: 8 bar / 116 psi
- Handle Material: Reinforced Nylon
- Frame Material: Steel
- Viscosity: Low/Medium

Item number: 152510



PNEUMATIC 1-COMPONENT DISPENSER

AIRFLOW™ 2 QUART



FEATURES

- Piston Rod Action on Cartridge Plunger
- Adjustable Air Regulator
- Quick Exhaust Valve
- Silencer

SPECIFICATIONS

- Cartridge Capacity: 946 mL / 32 oz
- Weight: 2.3 kg / 5.10 lbs
- Frame Length: 355 mm / 14 in
- Maximum Force: 1.5 kN / 337 lbf
- Maximum Pneumatic Pressure: 6.8 bar / 100 psi
- Handle Material: Glass Filled Nylon
- Barrel Material: Anodized Aluminum
- Frame Material: Epoxy Coated Steel
- Viscosity: Low/Medium

Item number: 159324



AIRFLOW™ 3 QUART



FEATURES

- Piston Rod Action on Cartridge Plunger
- Adjustable Air Regulator
- Quick Exhaust Valve
- Silencer

SPECIFICATIONS

- Cartridge Capacity: 946 mL / 32 oz
- Weight: 2.2 kg / 4.95 lbs
- Frame Length: 355 mm / 14 in
- Maximum Force: 31.5 kN / 37 lbf
- Maximum Pneumatic Pressure: 6.8 bar / 100 psi
- Handle Material: Glass Filled Nylon
- Barrel Material: Anodized Aluminum
- Frame Material: Epoxy Coated Steel
- Viscosity: Low/Medium

Item number: 159339



AIRFLOW™ 3 QUART UPRIGHT



FEATURES

- Piston Rod Action on Cartridge Plunger
- 45" Long with Joist Guide Attached
- Adjustable Air Regulator
- Quick Exhaust Valve
- Silencer

SPECIFICATIONS

- Cartridge Capacity: 946 mL / 32 oz
- Weight: 2.2 kg / 4.95 lbs
- Frame Length: 355 mm / 14 in
- Maximum Force: 1.5 kN / 337 lbf
- Maximum Pneumatic Pressure: 6.8 bar / 100 psi
- Handle Material: Glass Filled Nylon
- Barrel Material: Anodized Aluminum
- Frame Material: Epoxy Coated Steel
- Viscosity: Low/Medium

Item number: 159340



AIRFLOW™ 2 COMBI



FEATURES

- Piston Rod Action on Cartridge Plunger or Sachet
- Pre-Configured for Cartridge Application
- Sachet Plunger Included
- Adjustable Air Regulator
- Silencer
- Includes: Six White Cone Nozzles

SPECIFICATIONS

- Cartridge Capacity: 310 mL / 10.5 oz
- Sachet Capacity: 310 mL / 10.5 oz
- Weight: 1.3 kg / 2.8 lbs
- Barrel Length: 211 mm / 8.3 in
- Maximum Force: 1.5 kN / 337 lbf
- Maximum Pneumatic Pressure: 6.8 bar / 100 psi
- Handle Material: Glass Filled Nylon
- Barrel Material: Anodized Aluminum
- Viscosity: Low/Medium

Item number: 159327



PNEUMATIC 1-COMPONENT DISPENSER

AIRFLOW™ 3 COMBI



FEATURES

- Piston Rod Action on Cartridge Plunger or Sachet
- Pre-Configured for Cartridge Application
- Sachet Plunger Included
- Adjustable Air Regulator
- Silencer
- Includes: Six White Cone Nozzles

SPECIFICATIONS

- Cartridge Capacity: 310 mL / 10.5 oz
- Sachet Capacity: 310 mL / 10.5 oz
- Weight: 1.3 kg / 2.8 lbs
- Barrel Length: 211 mm / 8.3 in
- Maximum Force: 1.5 kN / 337 lbf
- Maximum Pneumatic Pressure: 6.8 bar / 100 psi
- Handle Material: Glass Filled Nylon
- Barrel Material: Anodized Aluminum
- Viscosity: Low/Medium

Item number: 159344



AIRFLOW™ 3 HP COMBI



FEATURES

- Piston Rod Action on Cartridge Plunger or Sachet
- Pre-Configured for Cartridge Application
- Plunger Included for Sachet Application
- Adjustable Air Regulator
- Silencer
- Includes: Six White Cone Nozzles

SPECIFICATIONS

- Cartridge Capacity: 310 mL / 10.5 oz
- Sachet Capacity: 310 mL / 10.5 oz, 600 mL / 20.3 oz
- Weight: 1.73-1.83 kg / 3.8-4.0 lbs
- Barrel Length: 210-347 mm / 8.3-13.6 in
- Maximum Force: 3.5 kN / 787 lbf
- Maximum Pneumatic Pressure: 6.8 bar / 100 psi
- Handle Material: Glass Filled Nylon
- Barrel Material: Anodized Aluminum
- Viscosity: Medium/High

Item number: 159342 (300 mL)
159343 (600 mL)



AIRFLOW™ 2 SACHET



FEATURES

- Floating Plunger Action with Secure Cord
- Adjustable Air Regulator
- Quick Exhaust Valve
- Silencer
- Includes: Six White Cone Nozzles

SPECIFICATIONS

- Sachet Capacity: 310 mL / 10.5 oz, 400 mL / 13.5 oz, 600 mL / 20.3 oz
- Weight: 0.95-1.12 kg / 2.1-2.5 lbs
- Barrel Length: 290 mm-437 mm / 11.4 in-17.2 in
- Maximum Force: 1.5 kN / 326 lbf
- Maximum Pneumatic Pressure: 6.8 bar / 100 psi
- Handle Material: Glass Filled Nylon
- Barrel Material: Anodized Aluminum
- Viscosity: Low/Medium

Item number: 159328 (300 mL)
159333 (400 mL)
159332 (600 mL)



AIRFLOW™ 3 SACHET

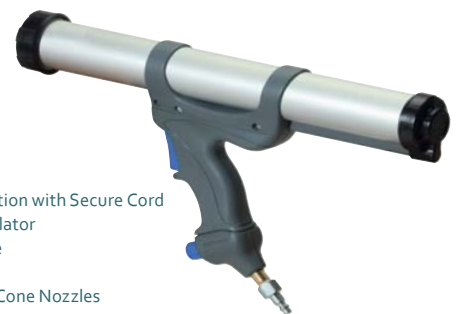

FEATURES

- Floating Plunger Action with Secure Cord
- Adjustable Air Regulator
- Quick Exhaust Valve
- Silencer
- Includes: Six White Cone Nozzles

SPECIFICATIONS

- Sachet Capacity: 310 mL / 10.5 oz, 400 mL / 13.5 oz, 600 mL / 20.3 oz
- Weight: 0.78-0.82 kg / 1.7-1.8 lbs
- Barrel Length: 297-436 mm / 11.7-17.2 in
- Maximum Force: 1.5 kN / 337 lbf
- Maximum Pneumatic Pressure: 6.8 bar / 100 psi, 8.6 bar / 125 psi
- Handle Material: Glass Filled Nylon
- Barrel Material: Anodized Aluminum
- Viscosity: Low/Medium

Item number: 159345 (300 mL)
159346 (400 mL)
159347 (600 mL)



PNEUMATIC 1-COMPONENT DISPENSER

AIRFLOW™ 3 COMPACT COMBI



FEATURES

- Floating Plunger Action with Interchangeable System
- Pre-configured for Sachet Application
- Rod & Plunger included for Cartridge Application
- Adjustable Air Regulator
- Includes: Six White Cone Nozzles

SPECIFICATIONS

- Cartridge Capacity: 310 mL / 10.5 oz
- Sachet Capacity: 310 mL / 10.5 oz, 400 mL / 13.5 oz, 600 mL / 20.3 oz
- Weight: 0.99 kg / 2.2 lbs
- Barrel Length: 464 mm / 18.27 in
- Maximum Force: 1.5 kN / 337 lbf
- Maximum Pneumatic Pressure: 6.8 bar / 100 psi
- Handle Material: Glass Filled Nylon
- Barrel Material: Anodized Aluminum
- Viscosity: Low/Medium

Item number: 159341



JETFLOW™ 3



FEATURES

- Floating Plunger Action with Secure Cord
- Spray and Bead Application
- Dual Flow Controls Regulate
- Adjustable Air Regulator Incoming Air Flow and Pattern of Spray
- Includes: Nozzles Vary by Model

SPECIFICATIONS

- Cartridge Capacity: 310 mL / 10.5 oz
- Sachet Capacity: 310 mL / 10.5 oz, 400 mL / 13.5 oz, 600 mL / 20.3 oz
- Weight: 1.22-1.47 kg / 2.7-3.2 lbs
- Barrel Length: 346.8-445 mm / 13.7-17.5 in
- Maximum Force: 1.5 kN / 326 lbf
- Maximum Pneumatic Pressure: 6.8 bar / 100 psi
- Handle Material: Glass Filled Nylon
- Barrel Material: Anodized Aluminum
- Viscosity: Low/Medium

Item number: 159351 (300 mL ctg/ssg)

159352 (300 mL ctg)

159354 (300 mL ssg)

159355 (600 mL ssg)



AIRFLOW™ 1 BULK



FEATURES

- Piston Rod Action on Bulk Material
- Leather Plunger Assembly
- Reverse Air – Plunger Return with Trigger
- Adjustable Air Regulator
- Quick Exhaust Valve
- Includes: Six Yellow Cone Nozzles

SPECIFICATIONS

- Bulk Material: 700 mL / 24 oz
- Weight: 1.5 kg / 3.3 lbs
- Barrel Length: 900 mm / 35.4 in
- Maximum Force: 3.4 kN / 764 lbf
- Maximum Pneumatic Pressure: 6.8 bar / 100 psi
- Handle Material: Epoxy Coated Aluminum
- Barrel Material: Anodized Aluminum
- Viscosity: Low/Medium

Item number: 159335



BATTERY 1-COMPONENT DISPENSER

EASIPOWER™ PLUS



FEATURES

- Variable Speed Control
- Auto-Reverse Function
- Includes Battery & Charger

SPECIFICATIONS

- Cartridge Capacity: 310 mL / 10.5 oz
- Voltage: 10.8 V
- Battery Type: Li-ion
- Weight with Battery: 1.63 kg / 3.5 lbs
- Frame Length: 247.8 mm / 9.76 in
- Maximum Force: 2.5 kN / 562 lbf
- Battery Capacity: 1.5 Ah
- Battery Charge Time: 30 min.
- Handle Material: PC/ABS
- Frame Material: Epoxy Coated Steel
- Viscosity: Low/Medium

Item number: 161878



ELECTRAFLOW™ PLUS



FEATURES

- Variable Speed Control
- Auto-Reverse Function
- Includes Battery & Charger

SPECIFICATIONS

- Cartridge Capacity: 310 mL / 10.5 oz
- Voltage: 18 V
- Battery Type: Li-ion Bosch Professional 18 V System
- Weight with Battery: 2.38 kg / 5.2 lbs
- Frame Length: 247.8 mm / 9.76 in
- Maximum Force: 3.5 kN / 787 lbf
- Battery Capacity: 1.5 Ah
- Battery Charge Time: 30 min.
- Handle Material: PC/ABS
- Frame Material: Epoxy Coated Steel
- Viscosity: Medium/High

Item number: 167062

167029 (bare unit)



EASIPOWER™ PLUS QUART



FEATURES

- Variable Speed Control
- Auto-Reverse Function
- Includes Battery & Charger

SPECIFICATIONS

- Cartridge Capacity: 946 mL / 32 oz
- Voltage: 10.8 V
- Battery Type: Li-ion
- Weight with Battery: 1.63 kg / 3.5 lbs
- Frame Length: 347 mm / 13.66 in
- Maximum Force: 2.5 kN / 562 lbf
- Battery Capacity: 1.5 Ah
- Battery Charge Time: 30 min.
- Handle Material: PC/ABS
- Frame Material: Epoxy Coated Steel
- Viscosity: Low/Medium

Item number: 161879



ELECTRAFLOW™ PLUS QUART



FEATURES

- Variable Speed Control
- Auto-Reverse Function
- Includes Battery & Charger

SPECIFICATIONS

- Cartridge Capacity: 946 mL / 32 oz
- Voltage: 18 V
- Battery Type: Li-ion Bosch Professional 18 V System
- Weight with Battery: 2.65 kg / 5.8 lbs
- Frame Length: 347 mm / 13.66 in
- Maximum Force: 3.5 kN / 787 lbf
- Battery Capacity: 1.5 Ah
- Battery Charge Time: 30 min.
- Handle Material: PC/ABS
- Frame Material: Epoxy Coated Steel
- Viscosity: Medium/High

Item number: 167073

167072 (bare unit)



BATTERY 1-COMPONENT DISPENSER

EASIPOWER™ PLUS COMBI



FEATURES

- Variable Speed Control
- Auto-Reverse Function
- Includes Battery & Charger

SPECIFICATIONS

- Cartridge Capacity: 310 mL / 10.5 oz
- Sachet Capacity: 310 mL / 10.5 oz, 400 mL / 13.5 oz, 600 mL / 20.3 oz
- Voltage: 10.8 V
- Battery Type: Li-ion
- Weight with Battery: 1.86 kg / 4.1 lbs
- Barrel Length: 237 mm / 9.3 in
- Maximum Force: 2.5 kN / 562 lbf
- Battery Capacity: 1.5 Ah
- Battery Charge Time: 30 min.
- Handle Material: PC/ABS
- Barrel Material: Anodized Aluminum
- Viscosity: Low/Medium

Item number: 159181



ELECTRAFLOW™ PLUS COMBI



FEATURES

- Variable Speed Control
- Auto-Reverse Function
- Includes Battery & Charger

SPECIFICATIONS

- Cartridge Capacity: 310 mL / 10.5 oz
- Sachet Capacity: 310 mL / 10.5 oz, 400 mL / 13.5 oz, 600 mL / 20.3 oz
- Voltage: 18 V
- Battery Type: Li-ion Bosch Professional 18 V System
- Weight: 2.53 kg / 5.6 lbs
- Barrel Length: 237 mm / 9.3 in
- Maximum Force: 3.5 kN / 787 lbf
- Battery Capacity: 1.5 Ah
- Battery Charge Time: 30 min.
- Handle Material: PC/ABS
- Barrel Material: Anodized Aluminum
- Viscosity: Medium/High

Item number: 167071

167068 (bare unit)



MANUAL 2-COMPONENT DISPENSER

CBM 25



FEATURES

- Easy Loading Breech, Secure Fit
- Full Cartridge Support
- Compact Design

SPECIFICATIONS

- Cartridge Capacity: 50 mL / 1.7 oz (Rectangular Flange)
- Cartridge Ratio: 1:1
- Mechanical Advantage Ratio: 12:1
- Weight: 0.43 kg / 0.9 lbs
- Cartridge Holder Length: 105 mm / 4.1 inch
- Maximum Force: 2.5 kN / 562 lbf
- Handle Material: Epoxy Coated Steel
- Cartridge Holder Material: Glass Fiber Reinforced Nylon
- Viscosity: Low/Medium

Item number: 159260



MPD



FEATURES

- Simple Breech Loading Mechanism
- Engineered to Provide High Thrust
- Full Kit Version Available

SPECIFICATIONS

- Cartridge Capacity: 50 mL / 1.7 oz (Rectangular Flange)
- Cartridge Ratio: 1:1, 2:1, 4:1, 10:1 (Must Specify)
- Mechanical Advantage Ratio: 16:1
- Weight: 0.2 kg / 0.4 lbs
- Cartridge Holder Length: 125 mm / 4.9 in
- Maximum Force: 3.5 kN / 787 lbf
- Handle Material: Glass Fiber Reinforced Nylon
- Cartridge Holder Material: Glass Fiber Reinforced Nylon
- Viscosity: Low/Medium

Item number: 159306



MR 50



FEATURES

- Cartridge Flexibility
- Engineered to Provide High Thrust
- Simple Breech Loading Mechanism

SPECIFICATIONS

- Cartridge Capacity: 50 mL / 1.7 oz, 75 mL / 2.6 oz (S-type + Rectangular Flange)
- Cartridge Ratio: 1:1, 2:1, 4:1, 10:1 (Must Specify)
- Full Kit Version Available
- Mechanical Advantage Ratio: 12:1
- Weight: 0.24 kg / 0.5 lbs
- Cartridge Holder Length: 109 mm / 4.3 in
- Maximum Force: 2.5 kN / 562 lbf
- Handle Material: Glass Fiber Reinforced Nylon
- Cartridge Holder Material: Glass Fiber Reinforced Nylon
- Viscosity: Low/Medium

Item number: 159319 (round multi-ratio)
159315 (square multi-ratio)



PPM 75



FEATURES

- Support Discs for Secure Cartridge Fit
- Wear Compensating Device
- Sintered Steel Catch Plate

SPECIFICATIONS

- Cartridge Capacity: 150 mL / 5.3 oz (Stubby Cartridge System)
- Cartridge Ratio: 1:1
- Mechanical Advantage Ratio: 18:1
- Weight: 1.0 kg / 2.2 lbs
- Frame Length: 129 mm / 5.1 in
- Maximum Force: 3.5 kN / 787 lbf
- Handle Material: Epoxy Coated Aluminum
- Frame Material: Epoxy Coated Steel
- Viscosity: Low/Medium

Item number: 159262



MANUAL 2-COMPONENT DISPENSER

VBM 100



FEATURES

- Wear Compensating Device
- Sintered Steel Catch Plate
- Support Strap for Secure Cartridge Fit

SPECIFICATIONS

- Cartridge Capacity: 175 mL / 5.9 oz, 200 mL / 6.8 oz
- Cartridge Ratio: 1:1, 3:1
- Mechanical Advantage Ratio: 18:1
- Weight: 1.2 kg / 2.6 lbs
- Cartridge Holder Length: 166 mm / 6.5 in
- Maximum Force: 3.5 kN / 787 lbf
- Handle Material: Epoxy Coated Aluminum
- Frame Material: Epoxy Coated Steel
- Viscosity: Low/Medium

Item number: 159265



PPM 150



FEATURES

- Wear Compensating Device
- Sintered Steel Catch Plate
- Support Strap for Secure Cartridge Fit

SPECIFICATIONS

- Cartridge Capacity: 225 mL / 7.9 oz, 250 mL / 8.7 oz, 300 mL / 10.5 oz
- Cartridge Ratio: 1:1, 2:1, 3:1
- Mechanical Advantage Ratio: 18:1
- Weight: 1.52 kg / 3.3 lbs
- Frame Length: 236 mm / 14.4 inch
- Maximum Force: 73.5 kN / 87 lbf
- Handle Material: Epoxy Coated Aluminum
- Frame Material: Epoxy Coated Steel
- Viscosity: Medium/High

Item number: 159267



VBM 200



FEATURES

- Support Straps for Secure Cartridge Fit
- Sintered Steel Catch Plate
- Wear Compensation Device

SPECIFICATIONS

- Cartridge Capacity: 400 mL / 13.5 oz
- Cartridge Ratio: 1:1
- Mechanical Advantage Ratio: 18:1
- Weight: 1.5 kg / 3.3 lbs
- Frame Length: 211 mm / 8.3 in
- Maximum Force: 3.5 kN / 787 lbf
- Handle Material: Epoxy Coated Aluminum
- Frame Material: Epoxy Coated Steel
- Viscosity: Medium/High

Item number: 159272



VBM 200X



FEATURES

- Support Straps for Secure Cartridge Fit
- Sintered Steel Catch Plate
- Wear Compensation Device

SPECIFICATIONS

- Cartridge Capacity: 400 mL / 13.5 oz
- Cartridge Ratio: 1:1
- Mechanical Advantage Ratio: 25:1
- Weight: 1.6 kg / 3.5 lbs
- Frame Length: 211 mm / 8.3 in
- Maximum Force: 4.5 kN / 1011 lbf
- Handle Material: Epoxy Coated Aluminum
- Frame Material: Epoxy Coated Steel
- Viscosity: High

Item number: 159275



MANUAL 2-COMPONENT DISPENSER

DM2X 200



FEATURES

- Dual Drive Mechanism
- Ratio Selector Switch
- Brake Release
- Interchangeable Cartridge Trays and Plungers

SPECIFICATIONS

- Cartridge Capacity: 200 mL / 6.8 oz
- Cartridge Ratio: 1:1, 2:1, 4:1, 10:1
- Mechanical Advantage Ratio: 22:1
- Weight: 1.60 kg / 3.53 lbs
- Frame Length: 154.7 mm / 6.1 in
- Maximum Force: 5.2 kN / 1169 lbf
- Handle Material: Cast Aluminum
- Frame Material: Cast Aluminum
- Viscosity: High

Item number: 165803 (1:1/2:1)
165804 (4:1)
165805 (10:1)



VBM 200 MR

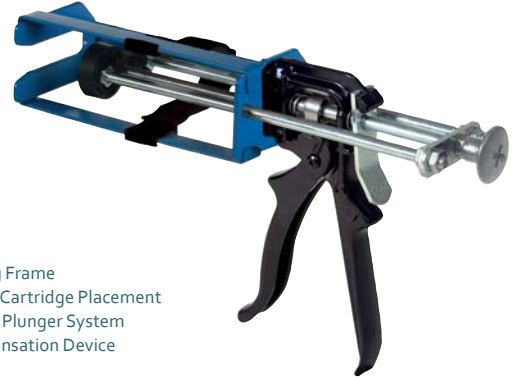

FEATURES

- Side Loading Frame for Accurate Cartridge Placement
- Twist & Lock Plunger System
- Wear Compensation Device

SPECIFICATIONS

- Cartridge Capacity: 200 mL / 6.8 oz
- Cartridge Ratio: 1:1, 2:1, 4:1, 10:1
- Mechanical Advantage Ratio: 18:1
- Weight: 1.5 kg / 3.3 lbs
- Frame Length: 166 mm / 6.5 in
- Maximum Force: 3.5 kN / 787 lbf
- Handle Material: Epoxy Coated Aluminum
- Frame Material: Epoxy Coated Steel
- Viscosity: Low/Medium

Item number: 159274



VBM 200X MR



FEATURES

- Side Loading Frame for Accurate Cartridge Placement
- Twist & Lock Plunger System
- Wear Compensation Device

SPECIFICATIONS

- Cartridge Capacity: 200 mL / 6.8 oz
- Cartridge Ratio: 1:1, 2:1, 4:1, 10:1
- Mechanical Advantage Ratio: 25:1
- Weight: 1.7 kg / 3.6 lbs
- Frame Length: 200 mm / 7.9 in
- Maximum Force: 4.5 kN / 1011 lbf
- Handle Material: Epoxy Coated Aluminum
- Frame Material: Epoxy Coated Steel
- Viscosity: High

Item number: 159278



PPM 300 LV



FEATURES

- Pre-Configured 2:1 Cartridge Ratio
- Support Discs for Secure Cartridge Fit
- Wear Compensation Device

SPECIFICATIONS

- Cartridge Capacity: 450 mL / 15.8 oz, 600 mL / 20.3 oz
- Cartridge Ratio: 1:1, 2:1 (3:1 available)
- Mechanical Advantage Ratio: 12:1
- Weight: 1.7 kg / 3.7 lbs
- Frame Length: 240 mm / 9.4 in
- Maximum Force: 2.5 kN / 562 lbf
- Handle Material: Epoxy Coated Aluminum
- Frame Material: Epoxy Coated Steel
- Viscosity: Low

Item number: 159284 (2:1)



MANUAL 2-COMPONENT DISPENSER

PPM 300 XL



FEATURES

- Support Discs for Secure Cartridge Fit
- Sintered Steel Catch Plate
- Wear Compensation Device

SPECIFICATIONS

- Cartridge Capacity: 375 mL / 12.7 oz, 450 mL / 15.3 oz, 600 mL / 20.3 oz
- Cartridge Ratio: 1:1, 2:1, 4:1 (3:1 available)
- Mechanical Advantage Ratio: 25:1
- Weight: 1.7 kg / 3.7 lbs
- Frame Length: 232 mm / 9.1 in
- Maximum Force: 4.5 kN / 1011 lbf
- Handle Material: Epoxy Coated Aluminum
- Frame Material: Epoxy Coated Steel
- Viscosity: High

Item number: 159288



PPM 300X



FEATURES

- Support Discs for Secure Cartridge Fit
- Sintered Steel Catch Plate
- Wear Compensation Device
- Double Side Rails for Added Durability

SPECIFICATIONS

- Cartridge Capacity: 450 mL / 15.3 oz, 600 mL / 20.3 oz
- Cartridge Ratio: 1:1, 2:1 (3:1 & 4:1 available)
- Mechanical Advantage Ratio: 25:1
- Weight: 1.7 kg / 3.7 lbs
- Frame Length: 232 mm / 9.1 in
- Maximum Force: 4.5 kN / 1011 lbf
- Handle Material: Epoxy Coated Aluminum
- Frame Material: Epoxy Coated Steel
- Viscosity: High

Item number: 159287



H293



FEATURES

- U-Opening Cartridge Snap Fit
- Anti-Drip
- Trigger Integrated Brake Release
- Life Prolonging Adjustment Screw

SPECIFICATIONS

- Cartridge Capacity: 450 mL / 15.87 oz, 600 mL / 21.1 oz
- Cartridge Ratio: 1:1, 2:1
- Mechanical Advantage Ratio: 26:1
- Weight: 1.2 kg / 2.6 lbs
- Frame Length: 231 mm / 9.1 in
- Maximum Force: 5 kN / 1124 lbf
- Handle Material: Reinforced Nylon
- Frame Material: Reinforced Nylon
- Viscosity: High

Item number: 151767



CCM 380



FEATURES

- Coaxial Cartridge Systems
- Sintered Steel Catch Plate
- Wear Compensation Device

SPECIFICATIONS

- Cartridge Capacity: 380 mL / 13.4 oz
- Cartridge Ratio: 1:1, 2:1, 5:1, 10:1 (must specify)
- Mechanical Advantage Ratio: 18:1
- Weight: 1.1 kg / 2.3 lbs
- Frame Length: 181 mm / 7.1 in
- Maximum Force: 3.5 kN / 787 lbf
- Handle Material: Epoxy Coated Aluminum
- Frame Material: Epoxy Coated Steel
- Viscosity: Medium/High

Item number: 159293 (1:1)
159295 (10:1)



MANUAL 2-COMPONENT DISPENSER

DM2X 400



FEATURES

- Dual Drive Mechanism
- Ratio Selector Switch
- Brake Release
- Interchangeable Cartridge Trays and Plungers

SPECIFICATIONS

- Cartridge Capacity: 400 mL / 13.5z
- Cartridge Ratio: 1:1, 2:1, 4:1, 10:1
- Mechanical Advantage Ratio: 22:1
- Weight: 1.93 kg / 4.24 lbs
- Frame Length: 193 mm / 7.6 in
- Maximum Force: 5.2 kN / 1169 lbf
- Handle Material: Cast Aluminum
- Frame Material: Cast Aluminum
- Viscosity: High

Item number: 165807 (1:1/2:1)
165808 (4:1)
165809 (10:1)



VBM 400X MR



FEATURES

- Side Loading Frame for Accurate Cartridge Placement
- Sintered Steel Catch Plate
- Wear Compensation Device
- Multi-Ratio Version Available

SPECIFICATIONS

- Cartridge Capacity: 400 mL / 13.5 oz
- Cartridge Ratio: 1:1, 2:1, 4:1, 10:1 (must specify)
- Mechanical Advantage Ratio: 25:1
- Weight: 1.8 kg / 3.8 lbs
- Frame Length: 200 mm / 7.9 in
- Maximum Force: 4.5 kN / 1011 lbf
- Handle Material: Epoxy Coated Aluminum
- Frame Material: Epoxy Coated Steel
- Viscosity: High

Item number: 159300



PPM 600X



FEATURES

- Support Discs for Secure Cartridge Fit
- Sintered Steel Catch Plate
- Wear Compensation Device

SPECIFICATIONS

- Cartridge Capacity: 675 mL / 23 oz, 750 mL / 26 oz, 900 mL / 31.6 oz, 1200 mL / 42 oz
- Cartridge Ratio: 1:1, 2:1, 4:1, 8:1 (must specify)
- Mechanical Advantage Ratio: 25:1
- Weight: 2.1 kg / 4.8 lbs
- Frame Length: 230 mm / 9.1 in
- Maximum Force: 4.5 kN / 1011 lbf
- Handle Material: Epoxy Coated Aluminum
- Frame Material: Epoxy Coated Steel
- Viscosity: High

Item number: 159302 (2:1)



PPM 750X



FEATURES

- Support Discs for Secure Cartridge Fit
- Sintered Steel Catch Plate
- Wear Compensation Device

SPECIFICATIONS

- Cartridge Capacity: 825 mL / 29.0 oz
- Cartridge Ratio: 10:1
- Mechanical Advantage Ratio: 25:1
- Weight: 2.1 kg / 4.7 lbs
- Frame Length: 234 mm / 9.2 in
- Maximum Force: 4.5 kN / 1011 lbf
- Handle Material: Epoxy Coated Aluminum
- Frame Material: Epoxy Coated Steel
- Viscosity: High

Item number: 159305



MANUAL 2-COMPONENT DISPENSER

PPM 1500X



FEATURES

- Support Discs for Secure Cartridge Fit
- Sintered Steel Catch Plate
- Wear Compensation Device

SPECIFICATIONS

- Cartridge Capacity: 1500 mL / 52.8 oz
- Cartridge Ratio: 1:1
- Mechanical Advantage Ratio: 25:1
- Weight: 3.0 kg / 6.5 lbs
- Frame Length: 234 mm / 9.2 in
- Maximum Force: 4.5 kN / 1011 lbf
- Handle Material: Epoxy Coated Aluminum
- Frame Material: Epoxy Coated Steel
- Viscosity: High

Item number: 159304



PNEUMATIC 2-COMPONENT DISPENSER

TS408 MY-8



FEATURES

- One-Hand Pressure Adjustment
- Anti-Drip Function
- Quick Cartridge Exchange
- Reinforced Nylon Handle

SPECIFICATIONS

- Cartridge Capacity: 50 mL / 1.8 oz, 75 mL / 2.7 oz
- Cartridge Ratio: 1:1, 2:1, 10:1
- Weight: 0.73 kg / 1.6 lbs
- Dispenser Length: 257 mm / 10.1 in
- Maximum Force: 1.3 kN / 292 lbf
- Maximum Pneumatic Pressure: 8 bar / 116 psi
- Air Consumption: 40 liters/min
- Handle Material: Reinforced Nylon
- Cartridge Holder Material: Reinforced Nylon
- Viscosity: Medium/High

Item number: 151780



TS408 HM-101



FEATURES

- One-Hand Pressure Adjustment
- Anti-Drip Function
- Quick Cartridge Exchange
- Reinforced Nylon Handle

SPECIFICATIONS

- Cartridge Capacity: 50 mL / 1.8 oz
- Cartridge Ratio: 10:1
- Weight: 0.73 kg / 1.6 lbs
- Dispenser Length: 184 mm / 7.2 in
- Maximum Force: 1.3 kN / 292 lbf
- Maximum Pneumatic Pressure: 8 bar / 116 psi
- Air Consumption: 40 liters/min
- Handle Material: Reinforced Nylon
- Viscosity: Low

Item number: 151886



TS408 EM



FEATURES

- One-Hand Pressure Adjustment
- Anti-Drip Function
- Quick Cartridge Exchange
- Reinforced Nylon Handle

SPECIFICATIONS

- Cartridge Capacity: 50 mL / 1.8 oz
- Cartridge Ratio: 1:1, 2:1, 3:2
- Weight: 0.73 kg / 1.6 lbs
- Dispenser Length: 232 mm / 9.1 in
- Maximum Force: 1.3 kN / 292 lbf
- Maximum Pneumatic Pressure: 8 bar / 116 psi
- Air Consumption: 40 liters/min
- Handle Material: Reinforced Nylon
- Cartridge Holder Material: Reinforced Nylon
- Viscosity: Medium/High

Item number: 151781



TS408 BM



FEATURES

- One-Hand Pressure Adjustment
- Anti-Drip Function
- Quick Cartridge Exchange
- Reinforced Nylon Handle

SPECIFICATIONS

- Cartridge Capacity: 50 mL / 1.8 oz
- Cartridge Ratio: 4:1, 10:1
- Weight: 0.73 kg / 1.6 lbs
- Dispenser Length: 278 mm / 10.9 in
- Maximum Force: 1.3 kN / 292 lbf
- Maximum Pneumatic Pressure: 8 bar / 116 psi
- Air Consumption: 40 liters/min
- Handle Material: Reinforced Nylon
- Cartridge Holder Material: Reinforced Nylon
- Viscosity: Medium/High

Item number: 153094



PNEUMATIC 2-COMPONENT DISPENSER

AIRFLOW™ 1 VBA 100 HP



FEATURES

- Adjustable Air Regulator
- Air Return as Standard
- Support Strap for Secure Cartridge Fit
- Quick Exhaust Valve

SPECIFICATIONS

- Cartridge Capacity: 200 mL / 7 oz
- Cartridge Ratio: 1:1
- Weight: 1.7 kg / 3.7 lbs
- Frame Length: 172 mm / 2.8 in
- Maximum Force: 2.2 kN / 494 lbf
- Maximum Pneumatic Pressure: 6.8 bar / 100 psi
- Air Consumption: 40 liters/min
- Handle Material: Epoxy Coated Aluminum
- Frame Material: Epoxy Coated Steel
- Viscosity: Low/Medium

Item number: 159367



AIRFLOW™ 1 PPA 150B



FEATURES

- Air Return as Standard
- Adjustable Air Regulator
- Quick Exhaust Valve
- Support Strap for Secure Cartridge Fit

SPECIFICATIONS

- Cartridge Capacity: 225 mL / 7.6 oz, 250ml / 8.5 oz, 300 mL / 10.5z
- Cartridge Ratio: 1:1, 2:1, 3:1 (must specify)
- Weight: 1.9 kg / 4.1 lbs
- Frame Length: 249 mm / 9.8 in
- Maximum Force: 2.2 kN / 494 lbf
- Maximum Pneumatic Pressure: 6.8 bar / 100 psi
- Air Consumption: 40 liters/min
- Handle Material: Epoxy Coated Aluminum
- Frame Material: Epoxy Coated Steel
- Viscosity: Low/Medium

Item number: 159369 (1:1)



AIRFLOW™ 1 VBA 200B



FEATURES

- Air Return as Standard
- Adjustable Air Regulator
- Quick Exhaust Valve
- Support Straps for Secure Cartridge Fit

SPECIFICATIONS

- Cartridge Capacity: 400 mL / 14 oz
- Cartridge Ratio: 1:1
- Weight: 2.2 kg / 4.8 lbs
- Frame Length: 216 mm / 8.5 in
- Maximum Force: 2.2 kN / 494 lbf
- Maximum Pneumatic Pressure: 6.8 bar / 100 psi
- Air Consumption: 40 liters/min
- Handle Material: Epoxy Coated Aluminum
- Frame Material: Epoxy Coated Steel
- Viscosity: Low/Medium

Item number: 159376



DP2X 200



FEATURES

- Plunger Retract Button
- Adjustable Air Regulator
- Quick Air Exhaust
- Indicator Rod
- Interchangeable Cartridge Trays and Plungers

SPECIFICATIONS

- Cartridge Capacity: 200 mL / 7 oz
- Cartridge Ratio: 1:1, 2:1, 4:1, 10:1
- Weight: 1.76 kg / 3.87 lbs
- Frame Length: 159.2 mm / 6.27 in
- Maximum Force: 2.5 kN / 562 lbf
- Maximum Pneumatic Pressure: 6.8 bar / 100 psi
- Air Consumption: 40 liters/min
- Handle Material: Reinforced Nylon
- Frame Material: Cast Aluminum
- Viscosity: Low/Medium

Item number: 165860 (1:1/2:1)

165861 (4:1)

165862 (10:1)



PNEUMATIC 2-COMPONENT DISPENSER

AIRFLOW™ 1&3 VBA 200B MR



FEATURES

- Side Loading Frame
- Twist & Lock Plunger System
- Air Return as Standard
- Adjustable Air Regulator
- Quick Exhaust Valve
- Support Strap for Secure Cartridge Fit

SPECIFICATIONS

- Cartridge Capacity: 200 mL / 7 oz
- Cartridge Ratio: 1:1, 2:1, 4:1, 10:1
- Weight: 1.7 kg / 3.7 lbs
- Frame Length: 172 mm / 6.7 in
- Maximum Force: 2.2 kN / 494 lbf
- Maximum Pneumatic Pressure: 6.8 bar / 100 psi
- Air Consumption: 40 liters/min
- Handle Material: Epoxy Coated Aluminum / Glass Filled Nylon
- Frame Material: Epoxy Coated Steel
- Viscosity: Low/Medium

Item number: 159375 (AF1)
181361 (AF3)



AIRFLOW™ 1&3 PPA 300B



FEATURES

- Air Return as Standard
- Adjustable Air Regulator
- Quick Exhaust Valve
- Support Discs for Secure Cartridge Fit

SPECIFICATIONS

- Cartridge Capacity: 375 mL / 13 oz, 400 mL / 13.5 oz, 450 mL / 16 oz, 600 mL / 21 oz
- Cartridge Ratio: 1:1, 2:1, 3:1, 4:1 (must specify)
- Weight: 0.88 kg / 1.9 lbs
- Frame Length: 224 mm / 8.8 in
- Maximum Force: 2.2 kN / 494 lbf
- Maximum Pneumatic Pressure: 6.8 bar / 100 psi
- Air Consumption: 40 liters/min
- Handle Material: Coated Aluminum / Glass Filled Nylon
- Frame Material: Epoxy Coated Steel
- Viscosity: Low/Medium

Item number: 159388 (AF1 multi-ratio)
159393 (AF3 1:1)
159394 (AF3 2:1)



AIRFLOW™ 1&3 PPA 300A



FEATURES

- Air Return as Standard
- Adjustable Air Regulator
- Quick Exhaust Valve
- Support Discs for Secure Cartridge Fit

SPECIFICATIONS

- Cartridge Capacity: 375 mL / 13 oz, 450 mL / 15.8 oz, 600 mL / 21.1 oz
- Cartridge Ratio: 1:1, 2:1, 4:1 (must specify)
- Weight: 3.3 kg / 7.2 lbs
- Frame Length: 236 mm / 9.3 in
- Maximum Force: 5 kN / 1124 lbf
- Maximum Pneumatic Pressure: 6.8 bar / 100 psi
- Air Consumption: 40 liters/min
- Handle Material: Epoxy Coated Aluminum / Glass Filled Nylon
- Frame Material: Epoxy Coated Steel
- Viscosity: Medium/High

Item number: 159382 (AF1 multi-ratio)
159386 (AF3 1:1)
159387 (AF3 2:1)



AIRFLOW™ 1&3 CCA 380A



FEATURES

- Coaxial Cartridge Systems
- Air Return as Standard
- Adjustable Air Regulator
- Quick Exhaust Valve

SPECIFICATIONS

- Cartridge Capacity: 380 mL / 13.4 oz
- Cartridge Ratio: 1:1, 2:1, 5:1, 10:1 (must specify)
- Weight: 2.5 kg / 5.5 lbs
- Frame Length: 178 mm / 7.0 in
- Maximum Force: 5 kN / 1124 lbf
- Maximum Pneumatic Pressure: 6.8 bar / 100 psi
- Air Consumption: 40 liters/min
- Handle Material: Epoxy Coated Aluminum / Glass Filled Nylon
- Frame Material: Epoxy Coated Steel
- Viscosity: Medium/High

Item number: 159399 (AF1 (1:1))
159401 (AF1 (10:1))
159402 (AF3 (10:1))



PNEUMATIC 2-COMPONENT DISPENSER

DP2X 400



FEATURES

- Plunger Retract Button
- Adjustable Air Regulator
- Quick Air Exhaust
- Indicator Rod
- Interchangeable Cartridge Trays and Plungers

SPECIFICATIONS

- Cartridge Capacity: 400 mL / 14 oz
- Cartridge Ratio: 1:1, 2:1, 4:1, 10:1
- Weight: 2.66 kg / 5.87 lbs
- Frame Length: 203.3 mm / 8.0 in
- Maximum Force: 5 kN / 1124 lbf
- Maximum Pneumatic Pressure: 6.8 bar / 100 psi
- Air Consumption: 40 liters/min
- Handle Material: Reinforced Nylon
- Frame Material: Cast Aluminum
- Viscosity: Medium/High

Item number: 165864 (1:1/2:1)
165865 (4:1)
165865 (10:1)



AIRFLOW™ 1 VBA 400B MR



FEATURES

- Air Return as Standard
- Adjustable Air Regulator
- Quick Exhaust Valve
- Multi Ratio Version Available
- Side Loading Frame for Accurate Cartridge Placement

SPECIFICATIONS

- Cartridge Capacity: 400 mL / 14 oz
- Cartridge Ratio: 1:1, 2:1, 4:1, 10:1 (must specify)
- Weight: 2.2 kg / 4.8 lbs
- Frame Length: 203 mm / 8.0 in
- Maximum Force: 2.2 kN / 494 lbf
- Maximum Pneumatic Pressure: 6.8 bar / 100 psi
- Air Consumption: 40 liters/min
- Handle Material: Epoxy Coated Aluminum
- Frame Material: Epoxy Coated Steel
- Viscosity: Low/Medium

Item number: 159411 (AF1 multi-ratio)



AIRFLOW™ 1 VBA 400A



FEATURES

- Air Return as Standard
- Adjustable Air Regulator
- Quick Exhaust Valve
- Side Loading Frame for Accurate Cartridge Placement

SPECIFICATIONS

- Cartridge Capacity: 400 mL / 14 oz
- Cartridge Ratio: 1:1, 2:1, 4:1, 10:1 (must specify)
- Weight: 3.1 kg / 6.8 lbs
- Frame Length: 203 mm / 8.0 in
- Maximum Force: 5 kN / 1124 lbf
- Maximum Pneumatic Pressure: 6.8 bar / 100 psi
- Air Consumption: 40 liters/min
- Handle Material: Epoxy Coated Aluminum
- Frame Material: Epoxy Coated Steel
- Viscosity: Medium/High

Item number: 159404 (AF1 1:1)
159407 (AF3 1:1)



AIRFLOW™ 1&3 PPA 600A



FEATURES

- Air Return as Standard
- Adjustable Air Regulator
- Quick Exhaust Valve
- Support Discs for Secure Cartridge Fit

SPECIFICATIONS

- Cartridge Capacity: 750 mL / 26.4 oz, 900 mL / 31.7 oz, 1200 mL / 42.0 oz
- Cartridge Ratio: 1:1, 2:1, 4:1 (must specify)
- Weight: 3.6 kg / 7.9 lbs
- Frame Length: 234 mm / 9.3 in
- Maximum Force: 5 kN / 1124 lbf
- Maximum Pneumatic Pressure: 6.8 bar / 100 psi
- Air Consumption: 40 liters/min
- Handle Material: Epoxy Coated Aluminum / Glass Filled Nylon
- Frame Material: Epoxy Coated Steel
- Viscosity: Medium/High

Item number: 159422 (AF1 2:1)
159425 (AF3 2:1)



PNEUMATIC 2-COMPONENT DISPENSER

AIRFLOW™ 1 CBA 600S



FEATURES

- Application of Dual 600 mL / 20 oz Sachets
- Air Return as Standard
- Quick Exhaust Valve
- Includes Manifold Assembly
- Adjustable Air Regulator

SPECIFICATIONS

- Cartridge Capacity: 1200 mL / 40 oz
- Cartridge Ratio: 1:1
- Weight: 3.6 kg / 7.9 lbs
- Frame Length: 357 mm / 14.1 in
- Maximum Force: 5 kN / 1124 lbf
- Maximum Pneumatic Pressure: 6.8 bar / 100 psi
- Air Consumption: 40 liters/min
- Handle Material: Epoxy Coated Aluminum
- Frame Material: Epoxy Coated Steel
- Viscosity: Medium/High

Item number: 159424



AIRFLOW™ 1&3 PPA 750A



FEATURES

- Air Return as Standard
- Adjustable Air Regulator
- Quick Exhaust Valve
- Support Discs for Secure Cartridge Fit

SPECIFICATIONS

- Cartridge Capacity: 825 mL / 29 oz
- Cartridge Ratio: 10:1
- Weight: 3.3 kg / 7.3 lbs
- Frame Length: 236 mm / 9.3 in
- Maximum Force: 5 kN / 1124 lbf
- Maximum Pneumatic Pressure: 6.8 bar / 100 psi
- Air Consumption: 40 liters/min
- Handle Material: Epoxy Coated Aluminum / Glass Filled Nylon
- Frame Material: Epoxy Coated Steel
- Viscosity: Medium/High

Item number: 159427 (AF1)
159431 (AF3)



AIRFLOW™ 1&3 PPA 1500A



FEATURES

- Air Return as Standard
- Adjustable Air Regulator
- Quick Exhaust Valve
- Support Discs for Secure Cartridge Fit

SPECIFICATIONS

- Cartridge Capacity: 1500 mL / 52.7 oz
- Cartridge Ratio: 1:1
- Weight: 3.3 kg / 7.3 lbs
- Frame Length: 236 mm / 9.3 in
- Maximum Force: 5 kN / 1124 lbf
- Maximum Pneumatic Pressure: 6.8 bar / 100 psi
- Air Consumption: 40 liters/min
- Handle Material: Epoxy Coated Aluminum / Glass Filled Nylon
- Frame Material: Epoxy Coated Steel
- Viscosity: Medium/High

Item number: 159426 (AF1)
159430 (AF3)



BATTERY 2-COMPONENT DISPENSER

ELECTRAFLOW™ DUAL ULTRA VBE 400 MR

FEATURES

- Bosch Battery
- Twin Drive Rack Platform
- Interchangeable Cartridge Straps & Plungers
- Includes: Battery & Charger
- Multi-Ratio Version

SPECIFICATIONS

- Cartridge Capacity: 400 mL / 13.5 oz
- Cartridge Ratio: 1:1, 2:1, 4:1, 10:1
- Voltage: 18 V
- Battery Type: Li-ion Bosch Professional 18 V System
- Weight: 3.8 kg / 8.4 lbs
- Frame Length: 203 mm / 8.0 in
- Maximum Force: 5 kN / 1124 lbf
- Battery Capacity: 2.0 Ah
- Battery Charge Time: 35 min
- Handle Material: PC/ABS
- Frame Material: Steel/Aluminum
- Viscosity: Medium/High

Item number: 163370
163287 (bare unit)



ELECTRAFLOW™ DUAL ULTRA VBE 600

FEATURES

- Bosch Battery
- Twin Drive Rack Platform
- Interchangeable Cartridge Straps & Plungers
- Includes: Battery & Charger

SPECIFICATIONS

- Cartridge Capacity: 600 mL / 21 oz
- Cartridge Ratio: 1:1
- Voltage: 18 V
- Battery Type: Li-ion Bosch Professional 18 V System
- Weight: 3.8 kg / 8.4 lbs
- Frame Length: 195 mm / 7.67 in
- Maximum Force: 5 kN / 1124 lbf
- Battery Capacity: 2.0 Ah
- Battery Charge Time: 2.0 Ah 35 min
- Handle Material: PC/ABS
- Frame Material: Steel/Aluminum
- Viscosity: Medium/High

Item number: 166731
166733 (bare unit)



PROFESSIONAL 18 V SYSTEM is a trademark registered and/or owned by BOSCH.

WARRANTY STATEMENT

COX™, MK™ and Mixpac™ dispensers are members of the medmix family of products.

COX™ EasiFlow™ and MidiFlow™ dispenser ranges are warranted for one (1) year from the date of invoice. All other COX™, MK™ and Mixpac™ dispensers ("medmix" or "medmix Products") are warranted for two (2) years from the date of invoice. medmix will repair or replace any medmix Product which is defective in material, workmanship or design.

LIMITATIONS:

This warranty does not cover:







1. Defective repairs made or attempted by a party other than medmix or an Authorized Service Center
2. Normal wear and tear
3. Misuse
4. Improper maintenance
5. Continued use after partial failure
6. Tools that have been modified or used with improper accessories

Should a problem develop while still under warranty, return the complete product to the point of purchase, an Authorized medmix Service Center or contact Sulzer Mixpac USA for Return Authorization. Defective product will be repaired or replaced at no charge.















The repair and replacement remedies described herein are exclusive. In no event shall Sulzer Mixpac be liable for any incidental, special, or consequential damages, including loss of profits, loss of use or loss of production.

This warranty is in lieu of all other warranties, expressed or implied including without limitation the implied warranties of merchantability and fitness for a particular purpose, which are expressly disclaimed.

DISPENSER ACCESSORIES

	Name/Description	Item Number	Compatible with
Nozzles			
	Plastic Nozzle Plastic nozzle adaptable with our H2,T20,T16 X MK 1-component dispensers.	178707	MK Models: H2, T20, T16 X, H3
	Plastic Nozzle Adaptable with many of our 1-component MK caulking dispensers (except the H2,T20 and T16 X).	152525	MK Models: H2 PS, H2 PSA, H3 PS, H3 PSA, H212 P, H2 P, H3 P, T22 XP
	Yellow Cone Nozzle Plastic clip-on sachet/bulk nozzle that can be cut to size to produce a 3-13 mm bead, has no graduation markings and is fitted directly under the front cap.	159115	All COX ø50 mm barrel sachet, bulk and combi dispensers
	White Cone Nozzle Plastic clip-on sachet nozzle that can be cut to size to produce a 3-13 mm bead and has no graduation markings. For use with all sachet and combi dispensers and is fitted directly under the front cap.	159116	All COX sachet, bulk and combi dispensers
Pistons			
	Steel "Tin Hat" Plunger 40 mm	158601	All COX manual 1-component cartridge dispensers except EasiFlow
	Split Sachet Plunger The three slits ensure more flexibility in the barrel	171202	All COX ø50 mm barrel sachet, bulk and combi dispensers
	Sachet Plunger Extension / Domed Plunger Eliminates waste	171187	All COX ø50mm barrel sachet, bulk and combi dispensers
	Green Plastic "G2" Plunger Best used in pairs to create better seal (sold separately)	158349	All COX ø50 mm barrel sachet, bulk and combi dispensers
	Leather Plunger Assembly For sachets and bulk application without nozzle holder; chemical and solvent resistant.	159072	All COX ø50 mm barrel sachet, bulk and combi dispensers
	Floating Sachet Plunger Drive	158820	COX AirFlow Compact Combi
	Floating Cartridge Plunger Drive	176947	COX AirFlow Compact Combi
	Piston for Cartridge	152549	MK Models: H212 P, H245, H2 PSA, H3 PSA, H14 RS, H2 PS, H3 PS, H40 PS, H2 PSA,
	Piston for Cartridge Square centre	152548	MK Models: H40, H45, H2 P, H3 P
	Piston for Sachets & Bulk	152539	MK Models: H3, H2, T20
	Piston for Sachets & Bulk	152543	MK Model: T22 XP
	Click ON/OFF Piston Easy conversion for cartridge to sachet	152544	MK Models: H2 PS, H2P, H3P, H2PSA, H3PSA, H3PS, B600 variants, H212P

DISPENSER ACCESSORIES

	Name/Description	Item Number	Compatible with
General Accessories			
	Plastic Two Start Cap Spare black plastic front cap. To use with clip-on nozzles for sachet and bulk. Screw-in nozzles can be used in conjunction with a nozzle holder and "O" ring (7N2007 - sold separately).	158187	COX Most ø50 mm barrelled dispensers with two start thread
	COX Ladder Hook Kit Black plastic ladder hook (incl. fixing) that allows you to hang the dispenser onto a ladder or the tool belt.	159071	COX PowerFlow, UltraFlow, Ultrapoint
	Aluminum Pull Handle	158941	All COX dispensers with Interchangeable T-Rod
	Support Handle	159100	COX All 2" barrel dispensers
	Union Cut	152981	MK H2
	Union Cut with Bayonet	152557	MK H2
	Gasket	152972	MK H3, H2, T20
	2 Gallon Follower Plate (2" Opening) For use with bulk loading dispensers. Works with straight and tapered pails. Pull rod included.	159150	COX All bulk dispensers
	5 Gallon Follower Plate (2" Opening) For use with bulk loading dispensers. Works with straight and tapered pails. Pull rod included.	159151	COX All bulk dispensers
	Turbine Mixer Epoxy coated steel mixer provides fast and efficient mixing, as material spins across horizontal plate and is propelled through battlements where it is dispersed.	159129	COX Ultrapoint
	American Quick Release Airline/Hose Connector option	158850	COX JetFlow, AirFlow
Battery Dispenser Accessories			
	Universal Battery Charger 10.8 V	159159	COX EasiPower Plus
	Lithium-ion Battery 10.8 V	159157	COX EasiPower Plus
	Bosch Professional Charger Universal battery charger for 18 V batteries.	163517 (EU) 165577 (UK) 165572 (US)	COX ElectraFlow Plus
	Bosch Professional Battery Lithium-ion battery, 18 V 2.0 Ah.	163515	COX ElectraFlow Plus

DELIVERING INNOVATION. INSPIRING CONFIDENCE.

EUROPE

Sulzer Mixpac AG

Ruetistrasse 7

9469 Haag, Switzerland

Phone +41 81 414 70 00

sales.industry@medmix.com

www.medmix.swiss

**USA, SOUTH AMERICA,
CANADA AND MEXICO**

Sulzer Mixpac USA Inc.

8181 Coleman Road

Haslett, MI 48840 USA

Phone +1 517 339 3330

sales.industry@medmix.com

www.coxdispensers.com/us

UK AND IRELAND

Sulzer Mixpac (UK) Ltd.

1 Tealgate, Charnham Park, Hungerford

Berkshire, RG17 0YT, United Kingdom

Phone: +44 (0)1488 647 800

sales.industry@medmix.com

www.coxdispensers.com

ASIA PACIFIC

Sulzer Mixpac China

68 Bei Dou Lu, Minhang Shanghai

200245, China

Phone: +86 21 6430 68 68

sales.industry@medmix.com

www.medmix.swiss



Legal Notice: This brochure is a general presentation. The information contained in this publication is believed to be accurate and reliable but is not to be construed as implying any warranty or guarantee of performance. We waive any liability and indemnity for effects resulting from its application. Please, contact us for a description of the warranties and guarantees offered with our products. Directions for use and safety will be given separately. All information herein is subject to change without notice.

© 2022 medmix All rights reserved.

medmix is a registered trademark belonging to medmix AG, and COX, MK, etc. and MIXPAC are registered trademarks belonging to Sulzer Mixpac AG.